

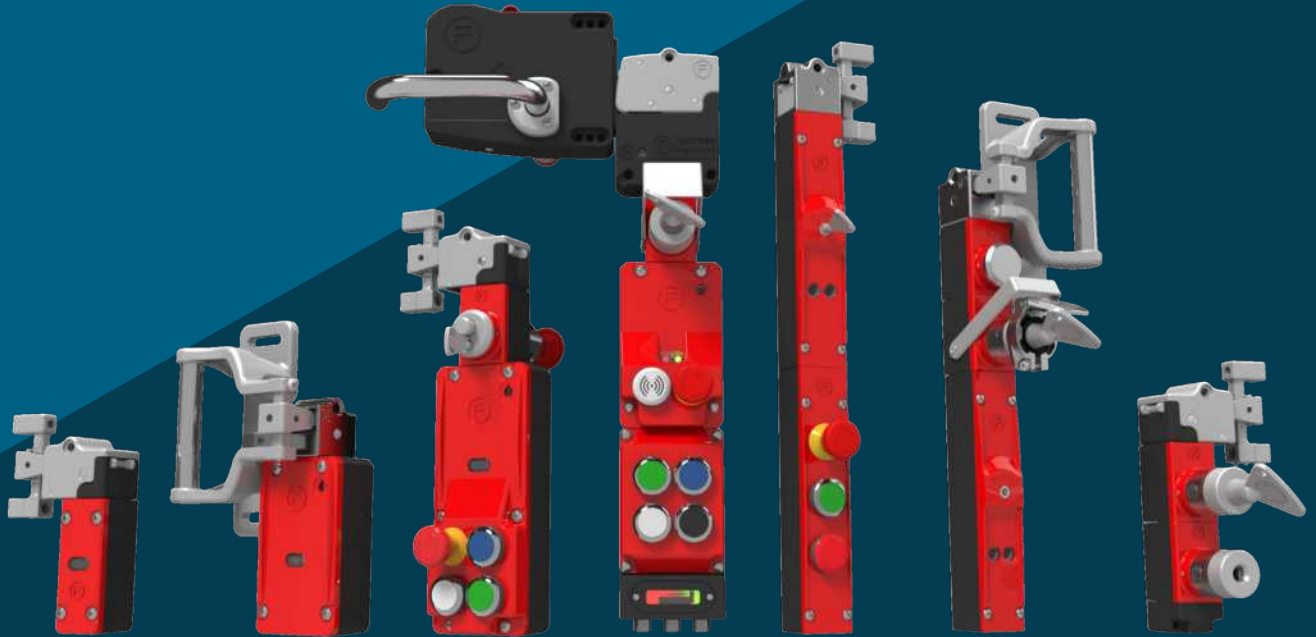

FORTRESS



Heavy Duty Guard Locking with PROFI-safe and CIP Safety



THE QUEEN'S AWARDS
FOR ENTERPRISE:
INTERNATIONAL TRADE
2018



EtherNet/IP



Gard pro



Introduction to amGardpro

A completely configurable safety interlocking solution allows specification of functionality to meet the exact requirements of your application. Pushbutton controls, ethernet connectivity and trapped key options can all be combined together into a single unit – providing a cost efficient solution compared to separate devices.

Fortress amGardpro products are designed, tested and TUV approved for use in Category 4/PLe safe control systems. The robust design and high strength rating of a Fortress interlock does not require additional safety components to be mounted to the gate to meet PLe. The integration of trapped keys within the unit can restrict access or protect employees during whole body access.

For connectivity, all devices can be specified with a quick disconnect receptacle and ordered with the correct mating cable in a variety of lengths. Or if ethernet architectures are preferred, safety over ethernet protocols can be integrated by using the *proNet* module which supports PROFINET/PROFIsafe and EtherNet/IP CIP safety.

Frank is the integration of existing site RFID access cards as part of a software based access approval system for manufacturing areas. Data is collected in the Fortress system for data insights that can support efficiency analysis.

Frank is the integration of existing site RFID access cards as part of a software based access approval system for manufacturing areas. Data is collected in the Fortress system for data insights that can support efficiency analysis.

When mounting to machine guarding, mounting plates can be pre-fitted to the Fortress units to reduce fixings required in installation down to two 40mm wide variants are also available to fit narrow profiles.

Note: Our online product configurators are available on our website - www.fortress-safety.com

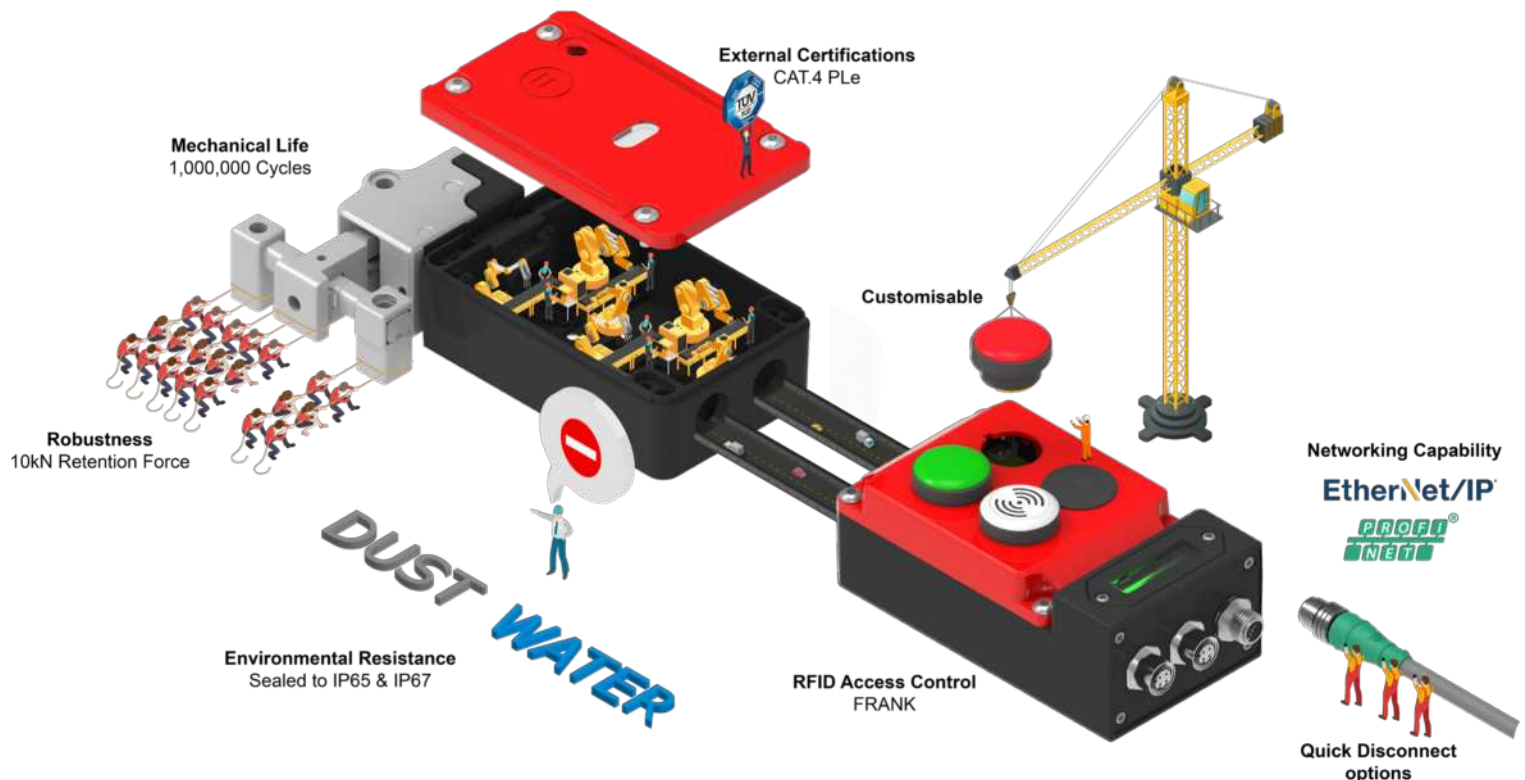
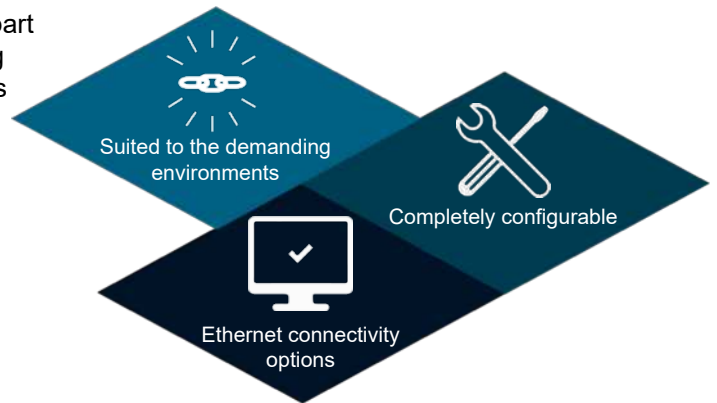

Access Hatches

Application Requirement:

Access points can require safeguarding with safety switches to ensure the process cannot run with guards open. Wire-to-the-guard solutions are suited to fast and frequent access demands. Processes that do not stop instantly should be safeguarded with solenoid guard locking solutions that only unlock the guard when it is safe to access.

Guard Switch

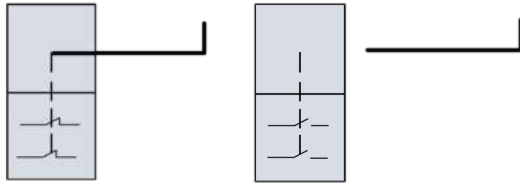

Guard opens, safety switches open

Guard Lock

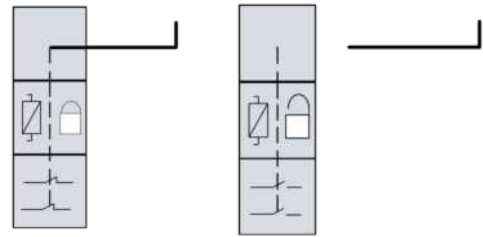

Guard is locked until machine stops, guard unlocking opens safety switches

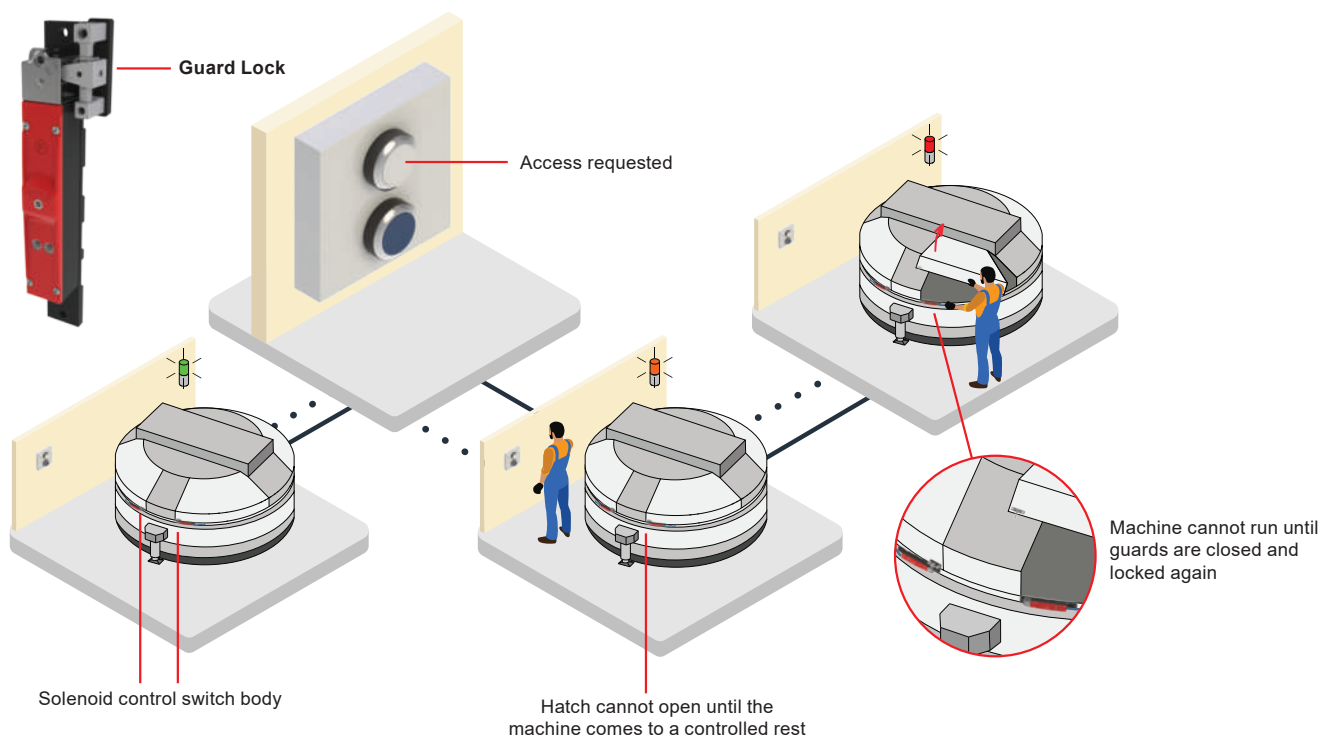
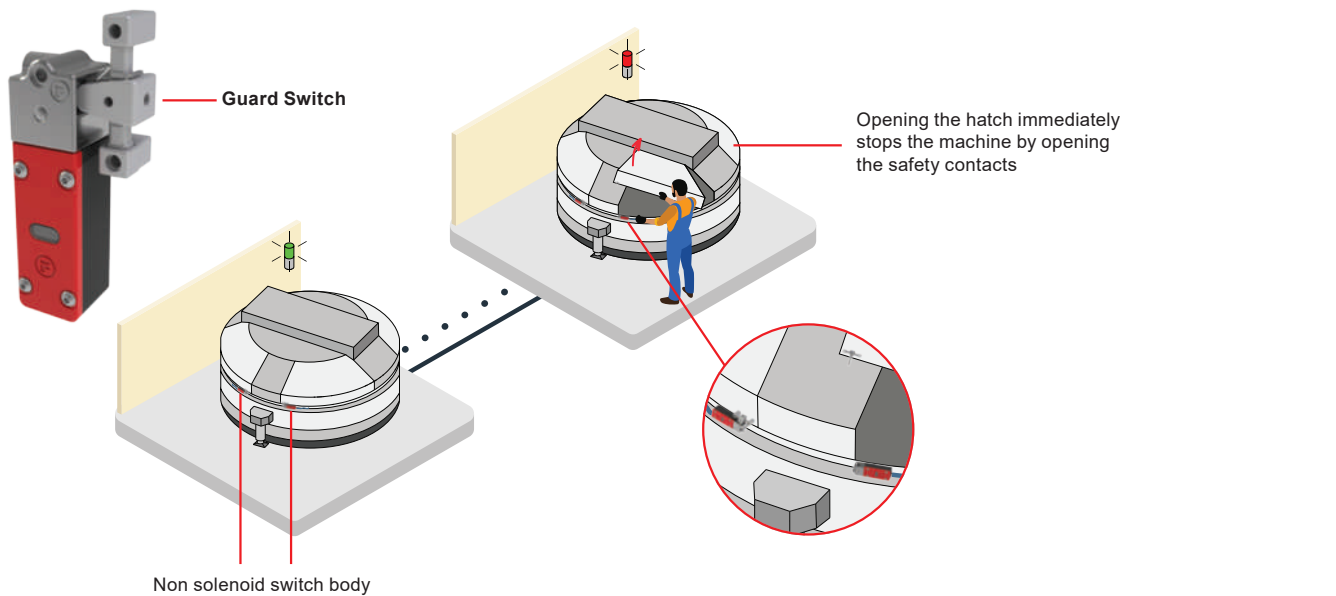

Robot Pallet Stacker

Application Requirement:

Robot arms require safeguarding measures during operation and when carrying loads. The robot pallet stacker below has two access points and a single central panel. When mains power is isolated to the system, the Power-to-Lock solenoid is de-energised and access keys for access points are released. Mechanical only interlocks at the guard can be opened with an access key whilst also providing a personnel key the operator is forced to take inside the cell to prevent restart in accordance to ISO 14118.

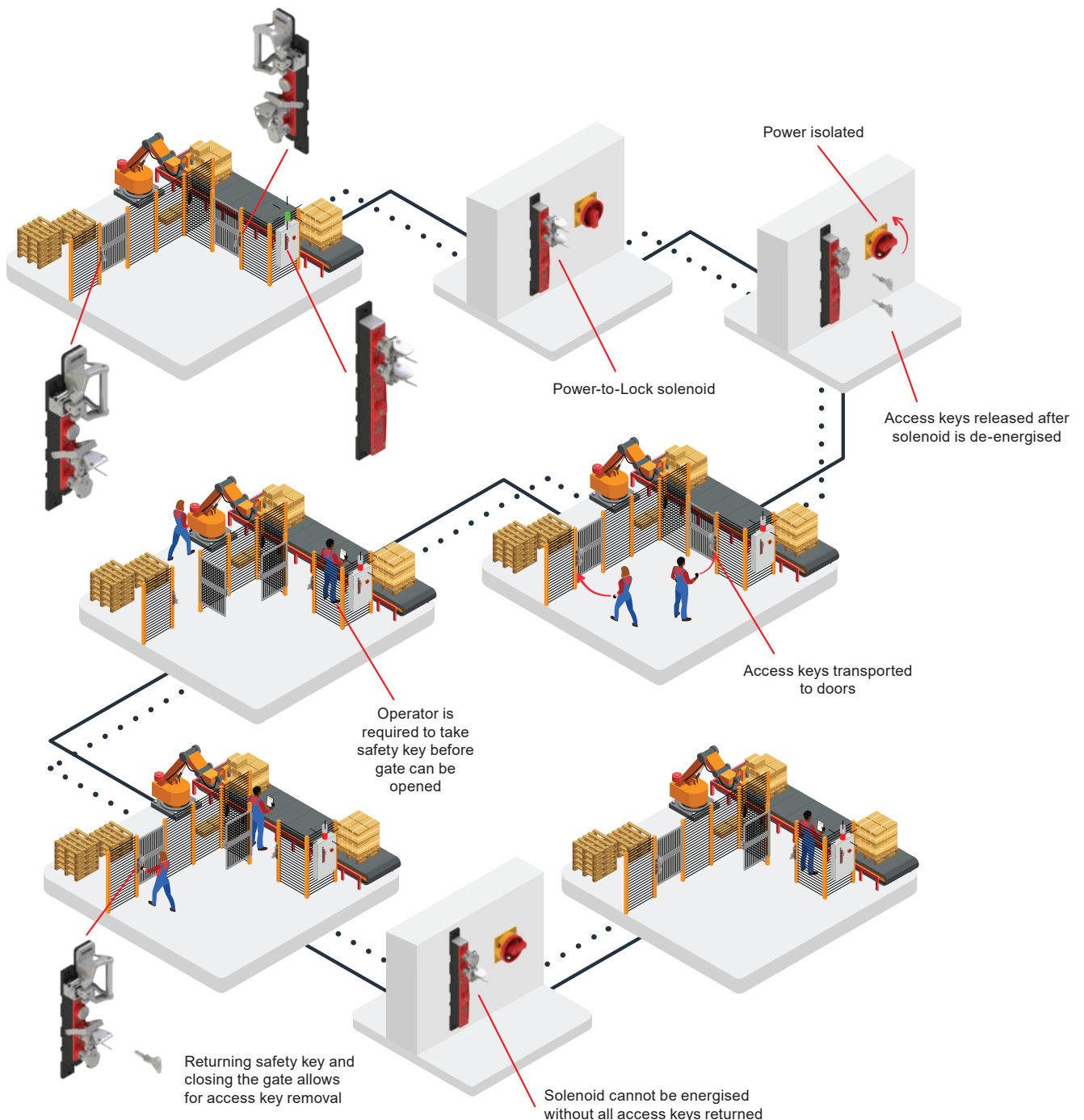
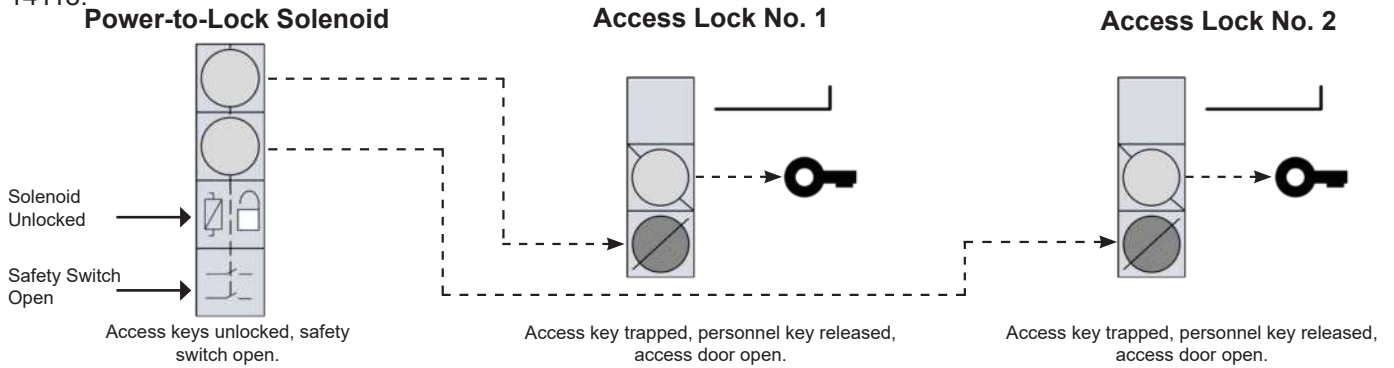

Slitting Line

Application Requirement:

Slitting lines require multiple safeguarding methods to cover different hazards. Safety controls for light curtains, guard locks and grab wires are integrated into two Ethernet connected Fortress units in the below application. Access is provided via RFID badges. The Fortress FRANK controller manages permissions and records data insights to restrict access based on training levels; Access frequency and duration can then be used for productivity analysis.

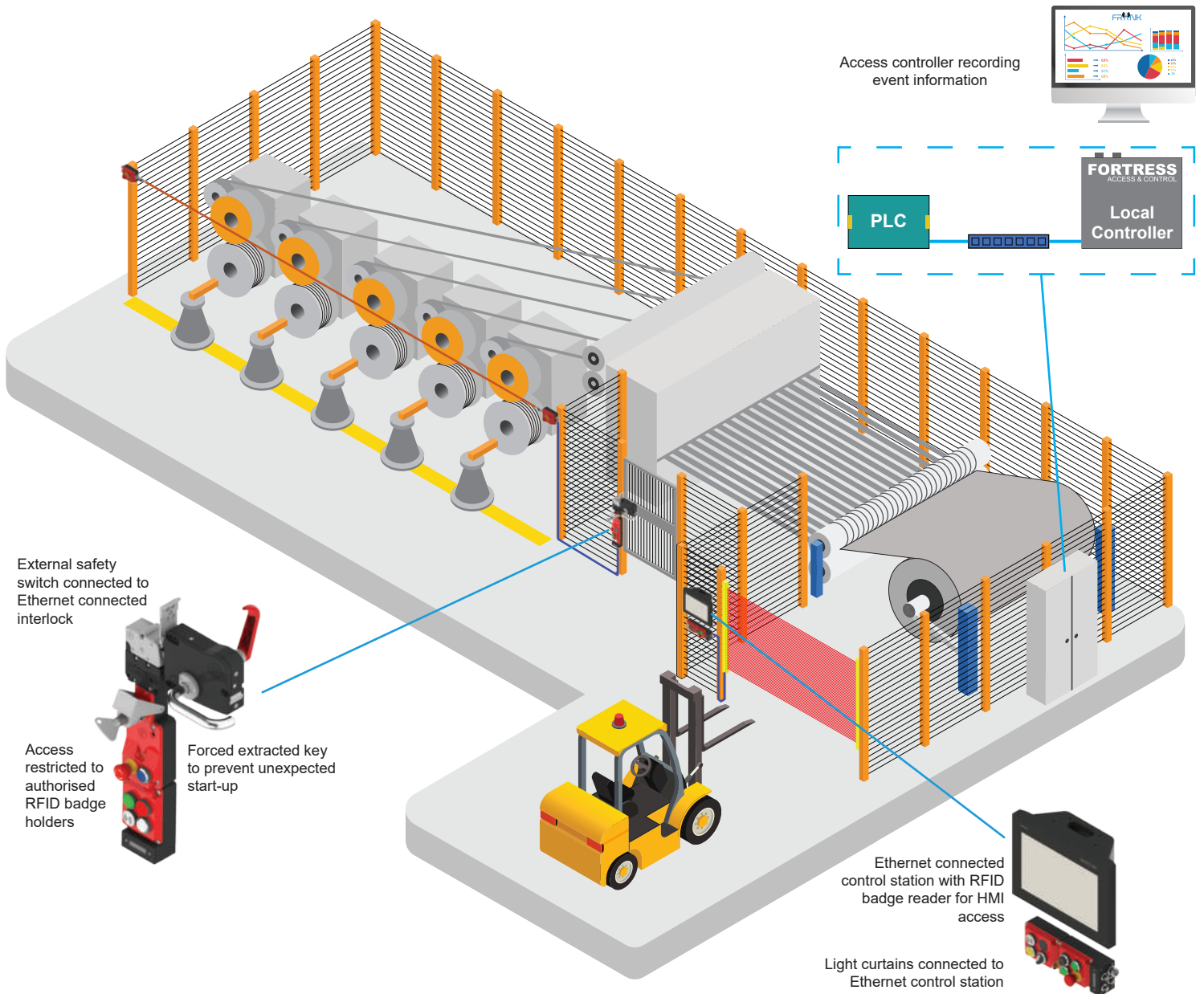
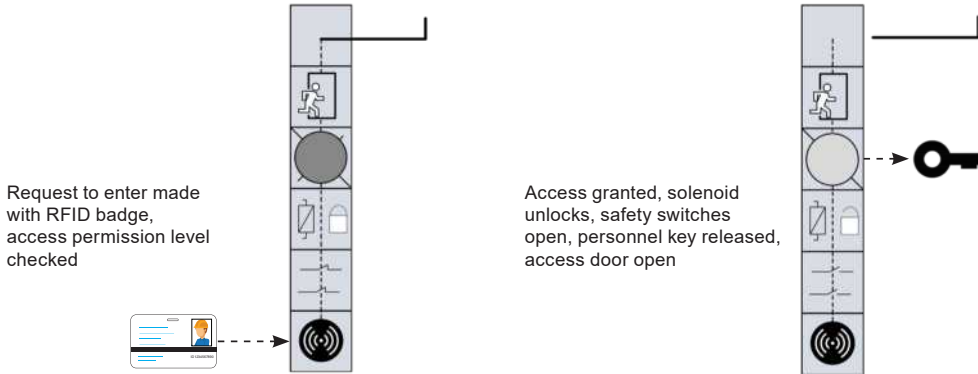

Automated Storage & Retrieval Systems

Application Requirement:

Automated storage and retrieval systems have aisle entry access at aisle ends and / or mid aisle points. For EN 528:2008 compliance, automatic crane control is disabled by a key switch mounted in an enclosure outside the aisle. This key permits access to the aisle via the interlock. The same key enables manual crane control via a key switch on the cart inside the aisle. See EN 528:2008 for further guidance.

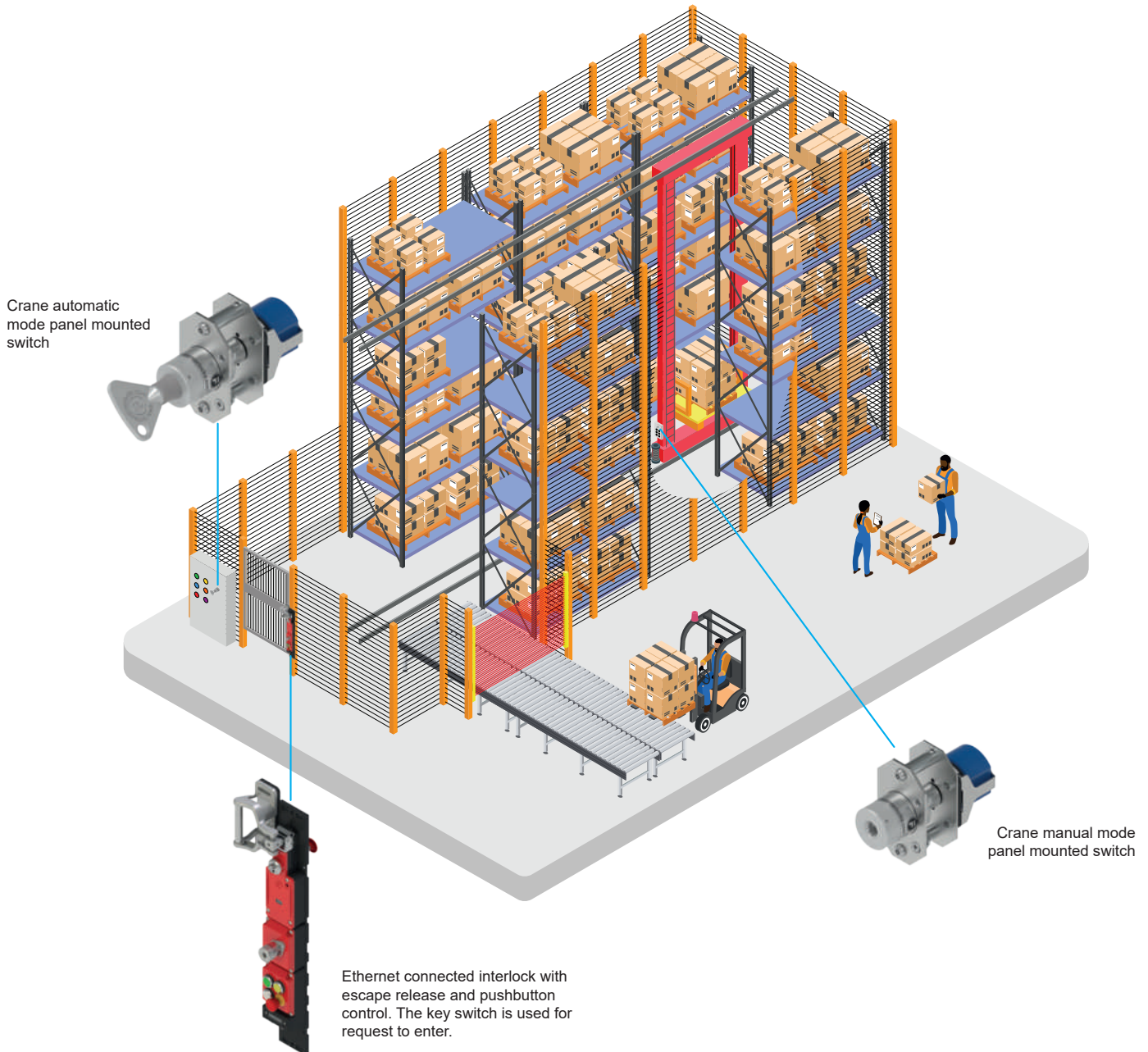
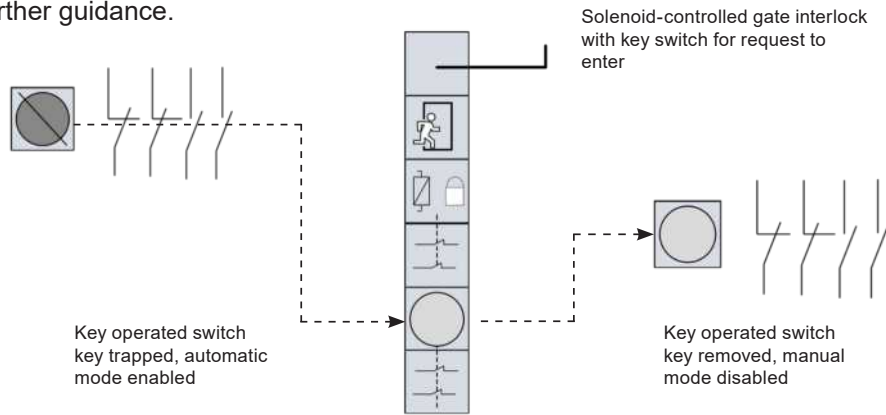

Guard Switch

2NC, 1NO heavy duty safety switch.



Guard Lock with Forced Extracted Key

Personnel key is required to be taken by the operator before guard opens.

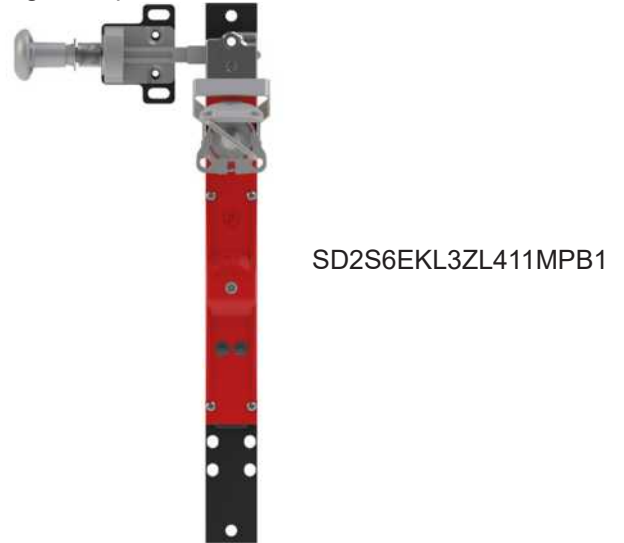

Guard Lock

Heavy duty Power-to-Unlock solenoid safety interlock.



Guard Lock with Single Action Escape Release

Ergonomic handle incorporates escape release in a single action. Operating red handle overrides locking mechanism and opens guard.

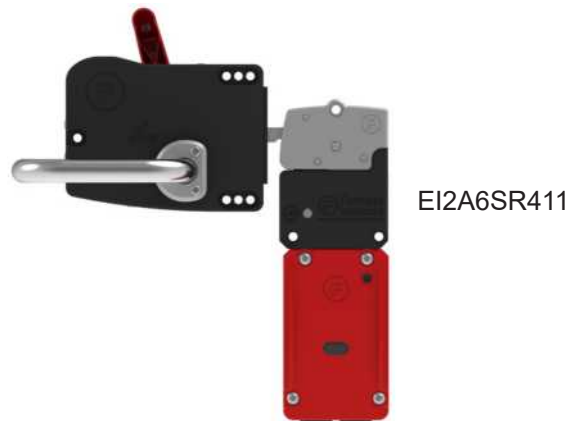

Guard Lock with Escape Release

Heavy duty safety interlock with escape release. Activation overrides locking mechanism and creates stop command.



Guard Lock with Integrated Ethernet Communication

PROFINET / PROFI-safe connectivity to the interlock. Pushbuttons & emergency stop incorporated at the guard. EtherNet/IP CIP safety also supported.

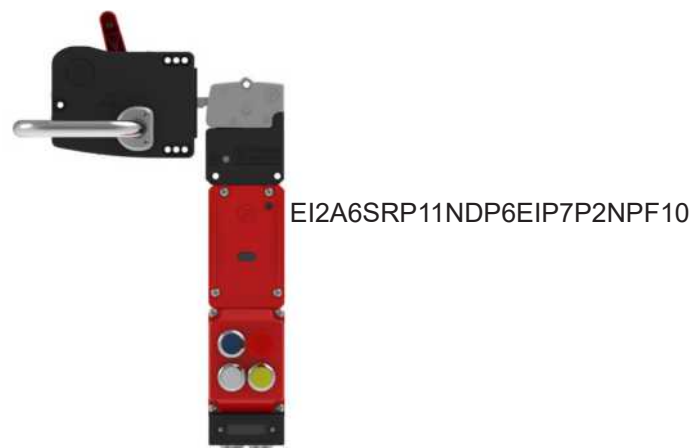

What is *proNet*?

Fortress' *proNet* allows Fortress devices to become distributed I/O on PROFINET or EtherNet/IP networks. Safety information is exchanged using the PROFIsafe or CIP safety. The *proNet* module can be configured for standalone control functionality, to power external devices via quick disconnects or as part of an amGard*pro* interlock unit.

Product Features:

- 3 dual channel safety inputs are supported. Can be utilised for guard locking, emergency stops and enabling switch connection all within one unit.
- Standard I/O for pushbutton / lamp functionality is extendable up to 40 I/O per configuration.
- An integrated network switch facilitates 'daisy-chain' bus topologies with no additional hardware.
- I6 I/O is available as protected external I/O via quick disconnects.
- F-address are set via web interface or DIP switches.
- Diagnostic functions available via web interface (supply voltage, current F-address, ethernet connection statistics).
- Variety of connection options including AIDA specification, M12 and 7/8" receptacles.

Control Stations

Fortress' *proNet* control stations are configurable network solutions aimed at reducing the cost of installation / ownership of bespoke fabrications with hardwired control functionality.

Costs associated with wiring time, panel building, panel space and the purchasing of enclosures, IO modules, terminals, multi core cables, industrial connectors at the machine or cell for the safety switches, sensors and interlocks can be avoided. Units arrive ready to be plugged into the network via quick disconnects.

Control and safety communication are transmitted over a single ethernet cable plugged into the Fortress unit. 3 dual channel safety inputs are supported with 1 dual channel safety output.

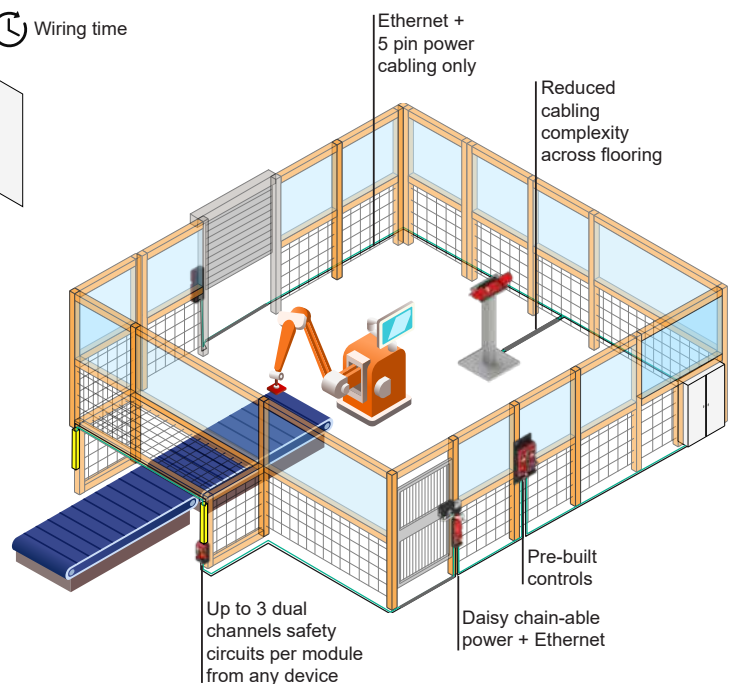
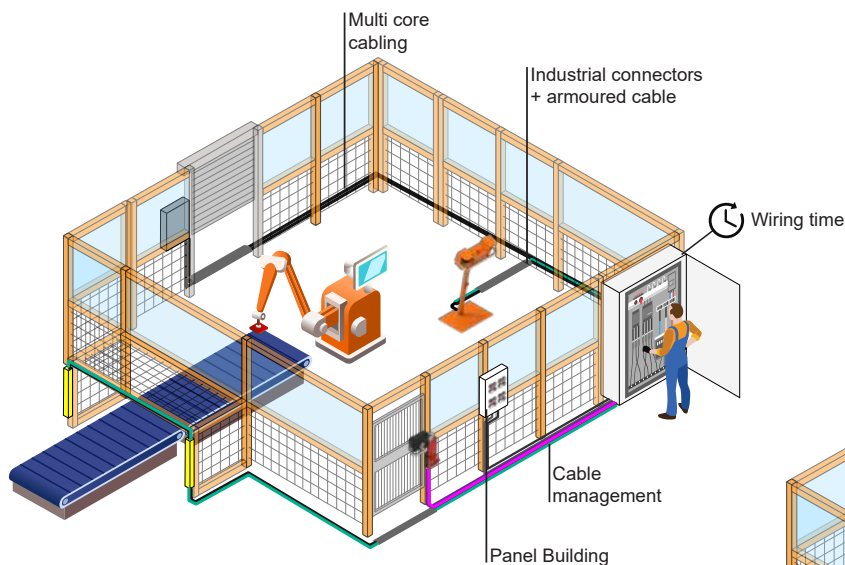
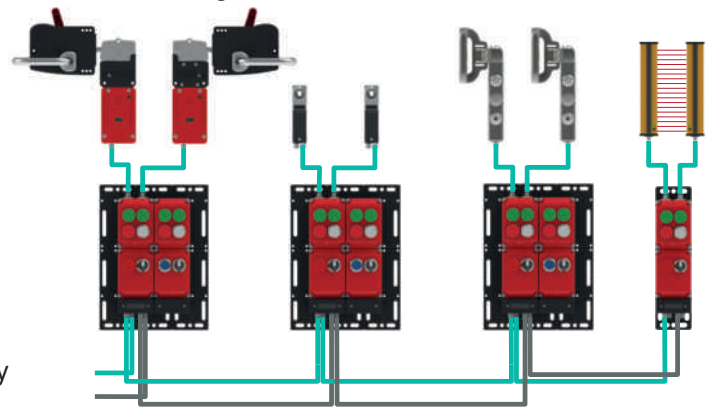

Fortress RFID Access Network Keys

Interlocks control when you can access equipment safely, Frank controls who can access equipment safely.

By integrating readers to suit the existing site RFID access cards into a Fortress device and providing a software based access approval control system; Frank can be integrated into automation systems with simple input / outputs to a PLC.

Data of who, when and where from access events is collated to a central point within facilities to allow for viewable events lists and data insights that can support efficiency analysis.

Fortress supports common card types including:

- 13.56MHz ISO 15693
- 13.56MHz with manufacturer's specific protocol
- 13.56MHz ISO 14443A
- 125kHz with manufacturer's specific protocol



Control Access

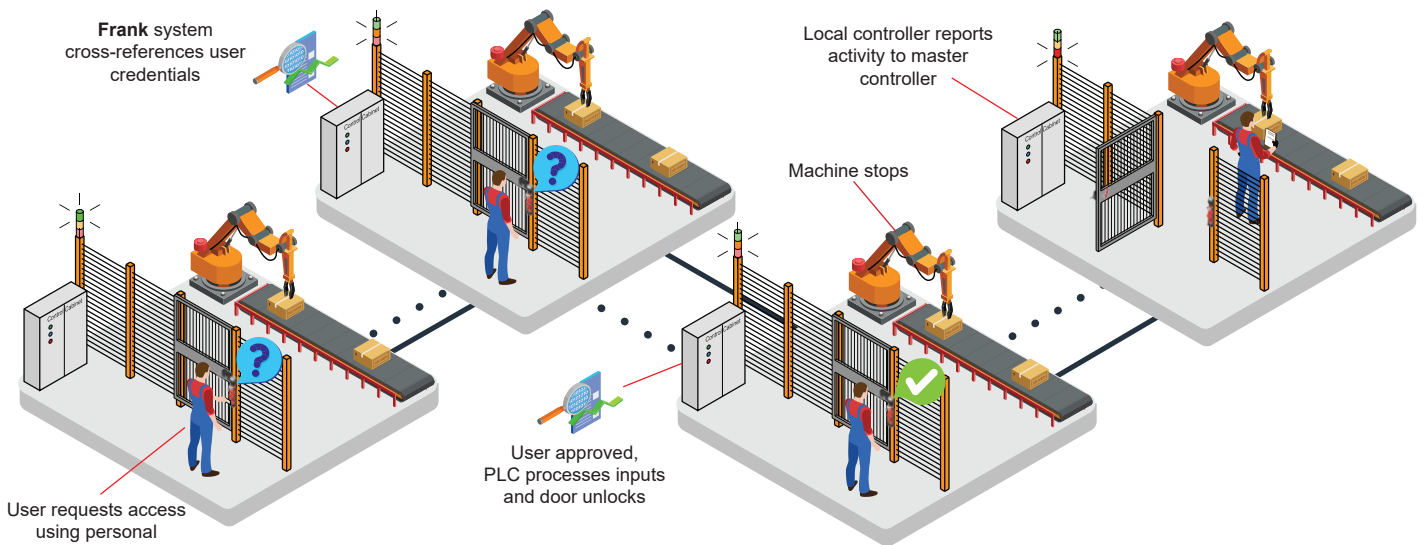

Manage Productivity

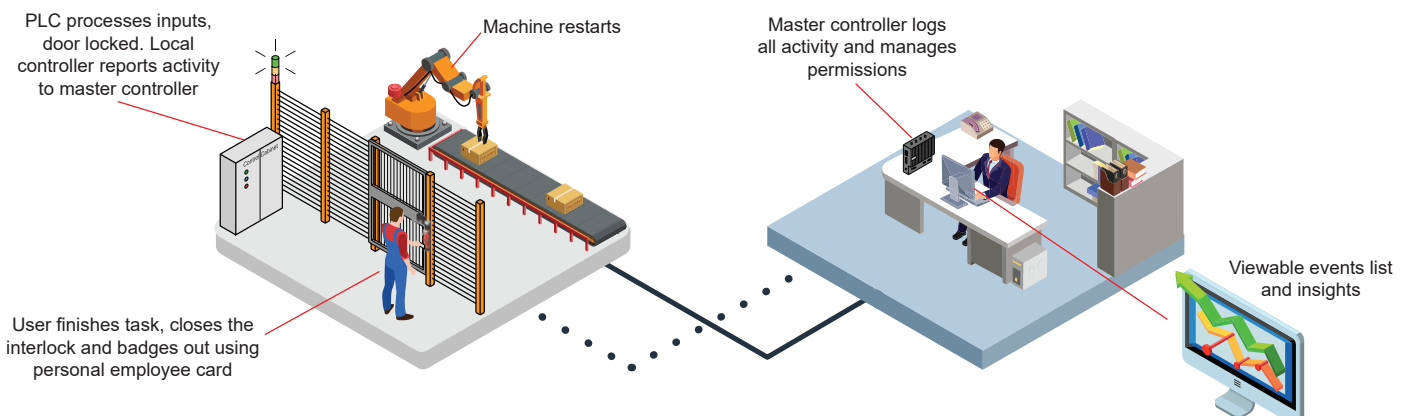

Misalignment Capability

Recognising that machine guarding installations often have a degree of variability and that guards move over time during use, Fortress provides market leading misalignment capability in the actuator offerings.

Actuator tongues can be moved vertically on a ratchet with angular misalignment also adsorbed by actuator design.

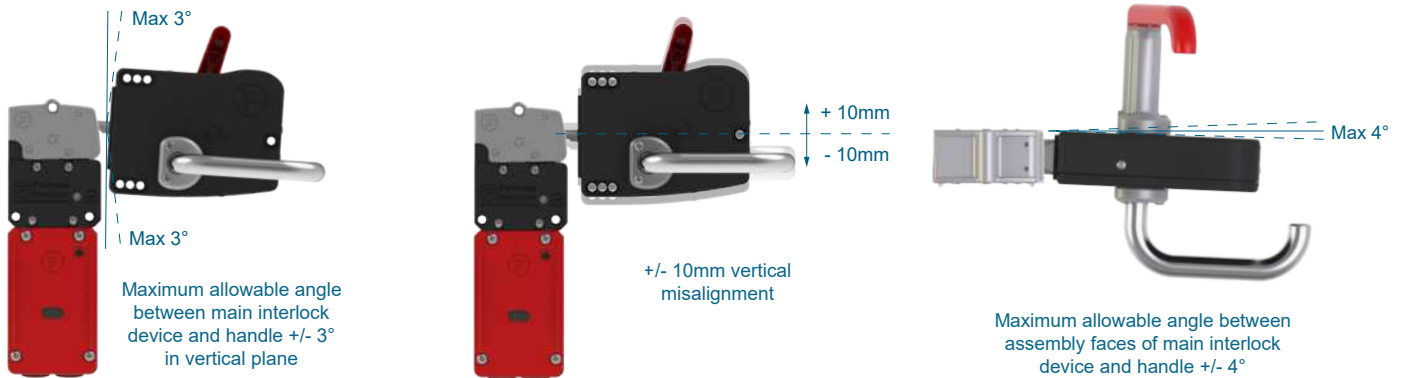

Mounting Plates

A series of packing and mounting plates to ensure most configured amGard^{pro} safety gate switches can easily and simply be fitted to machine guarding. The configurable plates are a robust design of die cast aluminium and are suitable for both hinged and sliding guards. The packing and mounting plates are pre-fitted to the interlock when ordered together and the mounting plates. However, they can also be ordered separately.

Without Mounting Plates

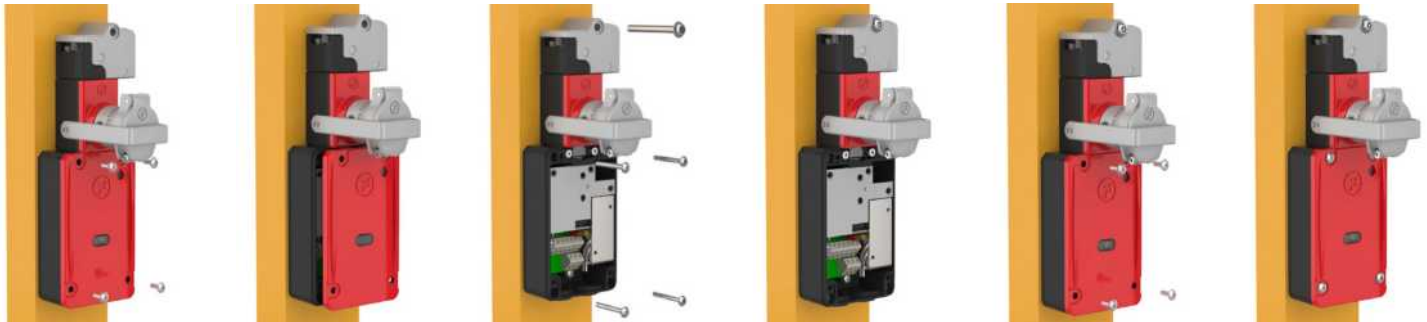

With Mounting Plates

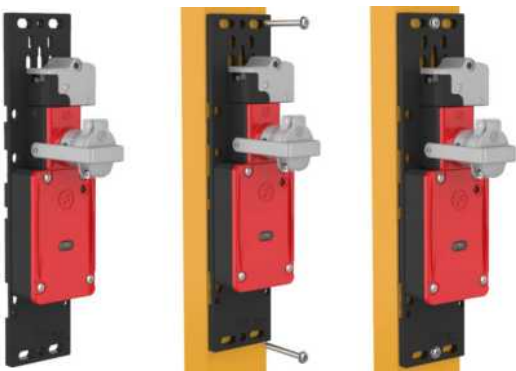

How to Configure:

The amGard^{pro} online configurator allows you to add a mounting plate at the end of your configuration which will automatically select the correct mounting and packing plate that your configured unit requires.

Actuator

Heads

Tongue



Handle Actuator



Short Hinged Handle



Long Hinged Handle



Slidebar



Rotary Insertion Handle



Mechanical Ends

Cap



Ergonomic Handle, No Interior Handle



Ergonomic Handle, Open & Close from Both Sides



Accessories

Drop Down Lock-Out



Lock-Out Clip



Single Action Escape Release Handle



Slimline Linear Insertion Head



Rotary Insertion Head



Linear Insertion Head



Single Action Escape Release Head



Escape Release Adaptors

Security Tool Reset



Pushbutton Reset



Trapped Key Adaptors

Extracted Key Adaptor



Safety Key Adaptor



Access Key Adaptor



Mounting Plates

Tongue & Rotary Insertion Handle



Ergonomic Handle



Switches / Locks

Slimline Solenoid Controlled Switch Body



Solenoid Controlled Switch Body



Non Solenoid Switch Body



Slidebar



Hinged Handle



40 mm



80 mm

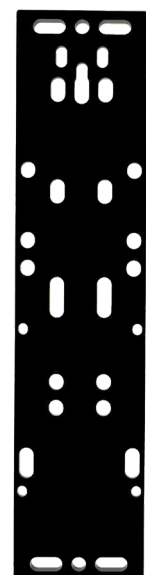

Option Pods

Slimline Pod



Key Switch Pod



Option Pod



Networked Option Pod



Mechanical Ends

Foot



5 Pin M12



8 Pin M12



10 Pin M12



12 Pin M12



19 Pin M23



Power & Data Connector Sets



Quick Disconnects

Step 1: Choose the Actuator, Handing & Head

Description	Information	Part No.
Linear insertion tongue	High strength and misalignment, suitable for all 'S' head configurations.	SA

Description	Information	Part No.
Tongue slidebar without a spring	Sliding motion holds door closed. With no return spring slidebar remains in the position it is left in.	SN

Description	Information	Part No.
Tongue slidebar with return spring	Sliding motion holds door closed. Return spring pulls the slidebar open when unlocked. Collision with interlock when closing guard avoided.	SS

Description	Information	Part No.
Short hinged handle	Short reach for use with 40mm wide units. (Removes need for separate handle on hinged guards).	HS1

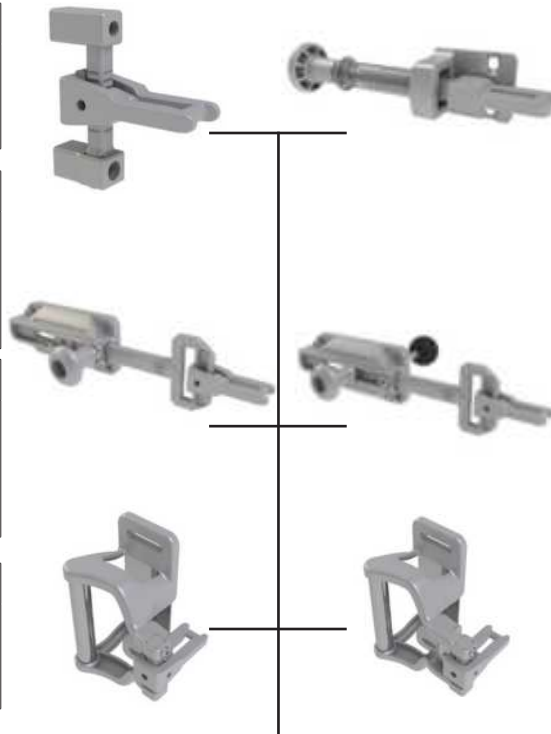

Description	Information	Part No.
Hand operated	Hand operated actuator with return spring.	SD

Description	Information	Part No.
Tongue slidebar with internal handle but no return spring	Sliding motion holds door closed. Same as a SN but escape release knob allows door to be opened only from the inside when main unit is unlocked.	SI

Description	Information	Part No.
Slimline tongue slidebar with internal handle c/w spacer behind the knob	Same as a SI but escape release knob allows door to be opened and closed from the inside when main unit is locked.	SF

Description	Information	Part No.
Long hinged handle	Long reach hinged handle for use with 80mm wide units.	HL1

Description Front facing	Part No. 1		Description Rear facing	Part No. 3
Description Left facing	Part No. 2		Description Right facing	Part No. 4

Description	Information	Part No.
Linear insertion slimline head	High strength and durability, suitable for all 'S' actuators and front / left / rear / right facings.	S6

Insert your part number selection here	Actuator	Handing	Head	Push Escape Release Adaptor	Trapped Key Adaptors			Guard Switch / Guard Lock

Step 1: Choose the Actuator, Handing & Head

Description	Information	Part No.
Linear insertion tongue	High strength and misalignment, suitable for all 'T' head configurations.	TA

Description	Information	Part No.
Slidebar without a spring	Sliding motion holds door closed. With no return spring slidebar remains in the position it is left in.	TN

Description	Information	Part No.
Slidebar with a return spring	Sliding motion holds door closed. Return spring pulls the slidebar open when unlocked. Collision with interlock when closing guard avoided.	TS



Description	Information	Part No.
<i>proHandle</i> no internal release	Ergonomic handle for machine guarding, but no method to open door from inside.	EN

Description	Information	Part No.
<i>proHandle</i> , with internal access handle	Ergonomic handle for machine guarding. Internal access handle allows to be opened and closed from the inside.	EF

Description	Information	Part No.
Slidebar with internal handle but no return spring	Sliding motion holds door closed. Same as a TN but escape release knob allows door to be opened only from the inside when main unit is unlocked.	TI

Description	Information	Part No.
Slidebar with internal handle c/w spacer behind the knob	Same as a TN but escape release knob allows door to be opened and closed from the inside when main unit is locked.	TF

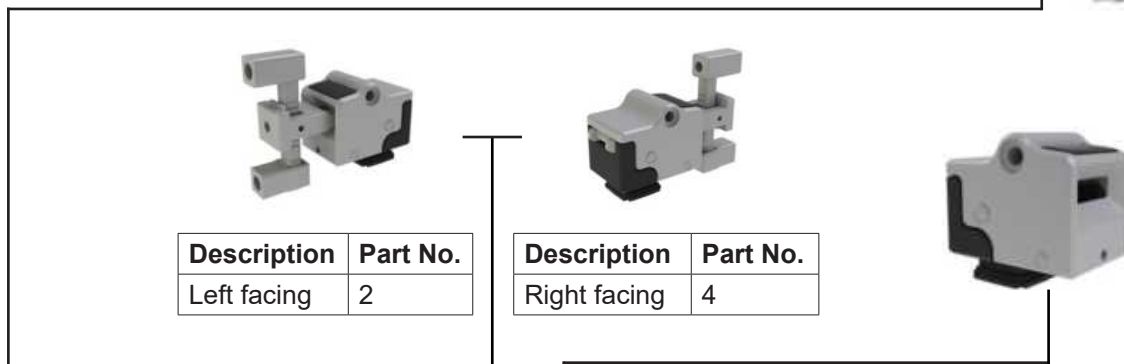

Description	Part No.
Left facing	2

Description	Part No.
Right facing	4

Description	Information	Part No.
Linear insertion head	High strength and durability, suitable for all 'T' actuators and left / right facings.	T6

Insert your part number selection here	Actuator	Handing	Head	Push Escape Release Adaptor	Trapped Key Adaptors			Guard Switch / Guard Lock

Step 1: Choose the Actuator, Handing & Head

Description	Information	Part No.
Rotary insertion handle	Turning motion holds door closed. Ideal for non locking set ups.	MA



Description	Information	Part No.
Single action escape release handle	Red handle overrides all locking mechanisms and opens safety contacts to allow escape release.	EI



Description	Information	Part No.
Single action escape release handle	Red handle overrides all locking mechanisms and opens safety contacts to allow escape release. Red handle can also close door from inside.	EJ

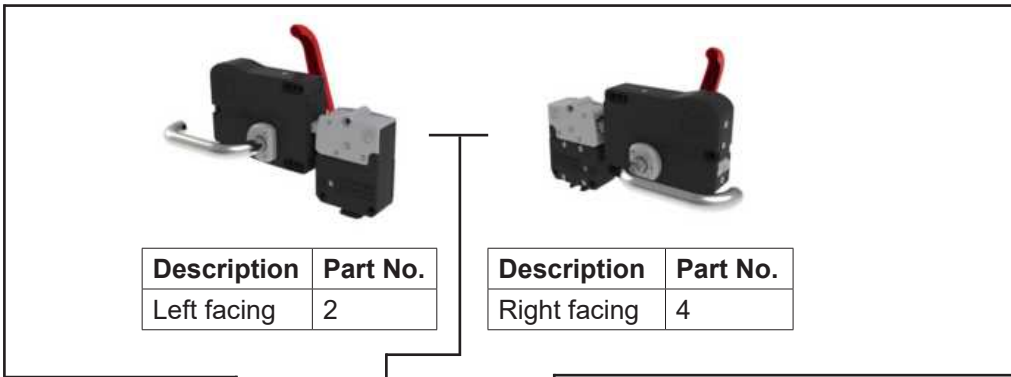

Description	Part No.
Left facing	2

Description	Part No.
Right facing	4

Insert your part number selection here	Actuator	Handing	Head	Push Escape Release Adaptor	Trapped Key Adaptors			Guard Switch / Guard Lock

Description	Information	Part No.
Rotary insertion head	Rotary insertion head suitable for MA actuator and left / right facings.	M6



Description	Information	Part No.
Single actions escape release head	Single action escape release head with automatic reset. Suitable for EI and EJ handle actuators and left / right facings.	A6



Description	Information	Part No.
Single actions escape release head with key reset	Single action escape release head with key reset. Suitable for EI and EJ handle actuators and left / right facings.	I6

Step 2: Do you want a Push Escape Release?

Description
 A push escape release adaptor will allow guard to open even if unit is locked by keys and / or solenoid. A push escape release adaptor is not needed if a single action escape release head and handle combination have already been specified.



Description	Information	Part No.
Pushbutton reset	Overrides all locking mechanisms and opens safety contacts to allow escape release. Simple push reset allows quick restart. Suitable for guards up to 60mm thick.	RX

Description	Information	Part No.
Pushbutton reset variable length	Same as RX but suitable. Suitable for guards up to 300mm thick.	RZ



Description	Information	Part No.
Security tool reset	Same as RX but key reset to ensure all incidents are reported those employees with a reset key.	R2

Description	Information	Part No.
Security tool reset variable length	Same as R2 but suitable. Suitable for guards up to 300mm thick.	R4

Insert your part number selection here	Actuator	Handing	Head	Push Escape Release Adaptor	Trapped Key Adaptors			Guard Switch / Guard Lock

am
 If a push escape release is not required leave part number blank and go to step 3.

Step 3: Choose a Trapped Key Adaptor

Forced extracted key for personnel to carry inside area



Additional safety keys for multiple personnel - SK



Access key required to unlock guard - AK



am
If you've selected an I6 / I7 / A6 / A7 or a push escape release adaptor then select a releasing lock.

Description	Part No.
Standard lock	L
Releasing lock (must be used if a push escape release or single action escape release head & handle selected).	R

Description	Part No.
Standard lock no dustcover	1
Standard lock with dustcover	2
Standard lock with padlockable dustcover	3
Masterable lock no dustcover	6
Masterable lock with dustcover	7
Masterable lock with padlockable dustcover	8

Description	Part No.
Standard lock	L
Releasing lock (must be used if a push escape release or single action escape release head & handle selected).	R

Description	Part No.
Standard lock no dustcover	1
Standard lock with dustcover	2
Standard lock with padlockable dustcover	3
Masterable lock no dustcover	6
Masterable lock with dustcover	7
Masterable lock with padlockable dustcover	8

Description	Part No.
Number of key adaptors required	1 - 9

am
Maximum total extracted, safety & access locks in one configuration is 9.

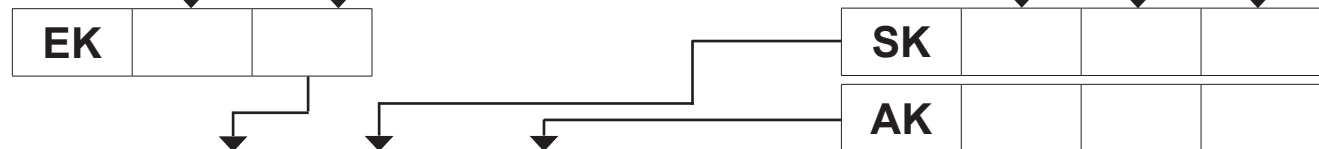

Insert your part number selection here	Actuator	Handing	Head	Push Escape Release Adaptor	Trapped Key Adaptors			Guard Switch / Guard Lock

Step 4: Choose an Electrical Switching / Locking Body

Description	Information	Part No.
Slimline LOK body	Solenoid controlled safety switch. Holds door locked until signal sent to unlock. 40mm wide.	ZL
Slimline LOK body - releasing	Same as ZL but allows push escape release adaptor override locking means. Only 40mm wide.	ZR

Description	Information	Part No.
LOK body	Solenoid controlled safety switch. Holds door locked until signal sent to unlock. 80mm wide.	SL
LOK body - releasing	Same as SL but allows push escape release adaptor or single action escape release head and handle to override locking means. Only 80mm wide.	SR

Description	Information	Part No.
STOP body	Non-locking safety switch.	ST



Voltage Options	Part No.
24v	4
proNet connection (80mm wide variants only)	P
110v (80mm wide variants only)	1
230v (80mm wide variants only)	2
ASi (80mm wide variants only)	8

Solenoid Type & Override Options	Part No.
No locking (safety switch units only)	0
Power-to-Unlock auxiliary release	1
Power-to-Unlock emergency release	2
Power-to-Lock (24v, 110v & ASi only)	6

Safety Switching Principle Options	Part No.
Safety on guard locking for Power-to-Unlock solenoid locking units. Power-to-Lock solenoid locking units are always safety on guard.	1
Safety on guard power solenoid locking units.	6

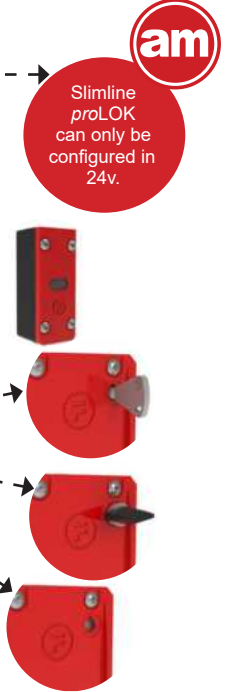

am
If you have selected a push escape release adaptor or single action escape release head and handle then select a releasing lock.

am
If no additional control functionality is required, skip to wiring step 9.

Insert your part number selection here	Actuator	Handing	Head	Push Escape Release Adaptor	Trapped Key Adaptors			Guard Switch / Guard Lock

Control Options - Once the basic interlock configuration is established, control functions can be added in 'Option Pods'



00
Blank



LR
Red Lamp



LY
Yellow Lamp



LG
Green Lamp



LB
Blue Lamp



LW
White Lamp



Laser Engraving
2 lines of 8 characters



ET
E-Stop (twist reset)



EP
E-Stop (pull reset)



EI
E-Stop (illuminated twist reset)



EM
E-Stop (with additional monitoring contacts, twist reset)



2E
Latching Selector Switch (illuminated)



2F
Momentary Selector Switch (illuminated)



K5
Latching Key Switch (90 degree)



PB
Black Non Illuminated Pushbutton



P1
Red Illuminated Pushbutton



P2
Yellow Illuminated Pushbutton



P3
Green Illuminated Pushbutton



P6
Blue Illuminated Pushbutton



P7
White Illuminated Pushbutton



Laser Engraving:
2 lines of 8 characters



RG
RFID Reader

am
Please contact Fortress to confirm your RFID reader.

am
2E, 2F & K5 options can only be fitted in top right or bottom left position.

am
If you don't require any additional control function, skip to step 9.

Step 5: Slimline Option Pods



Individual power supply units are available on request.

Description	Part No.
Standalone Slimline pod with common power supply.	V
Slimline pod to be fitted below <i>proStop</i> or Slimline <i>proLOK</i> unit with common power supply.	K



Select your pushbuttons, selector switches and lamps from the control option section in this ordering sequence:

1. Top position
2. Middle position
3. Bottom position



If an option pod isn't required, skip to wiring step 9.



Insert your part number selection here	Actuator	Handing	Head	Push Escape Release Adaptor	Trapped Key Adaptors			Guard Switch / Guard Lock	Slimline Option Pod

Step 6: Key Switch Pods



Description	Part No.
Standalone key switch pod with no holes on top of pod case.	0
Key switch pod with two holes on top for fitting to guard interlock assembly.	2



Description	Part No.
Standard Lock no dustcover	1
Standard Lock with dustcover	2
Standard Lock with padlockable dustcover	3
Masterable Lock no dustcover	6
Masterable Lock with dustcover	7
Masterable Lock with padlockable dustcover	8



am
2NO / 2NC safety switch activated by key and separate from locking switches. Common uses are to request machine stop enable teach modes or prevent machine restart.

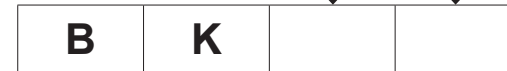

Insert your part number selection here	Actuator	Handing	Head	Push Escape Release Adaptor	Trapped Key Adaptors			Guard Switch / Guard Lock	Key Switch Option Pod

Step 7: Option Pods

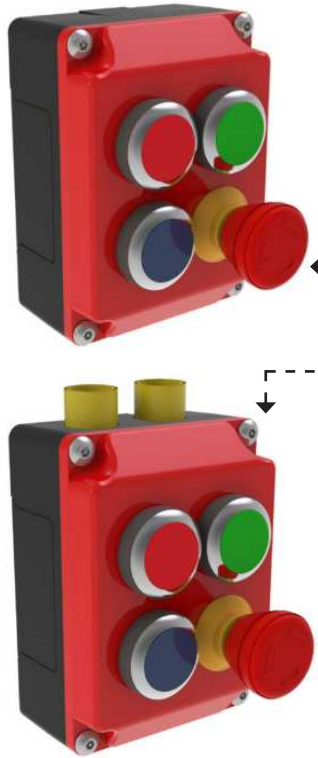

Description	Part No.
Standalone option pod with no holes on top of pod case.	V
Option pod with two holes on top of pod case for fitting to <i>proLOK</i> body.	J



Select your pushbuttons, selector switches and lamps from the control option section in this ordering sequence:

1. Top left
2. Top right
3. Bottom left
4. Bottom right

Sensors - 24v only	Part No.
No sensor	N
Coded magnet - Left hand	C
Coded magnet - Right hand	D
RFID sensor - Left hand	X
RFID sensor - Right hand	Q
Magnetic sensor - Left hand	F
Magnetic sensor - Right hand	J

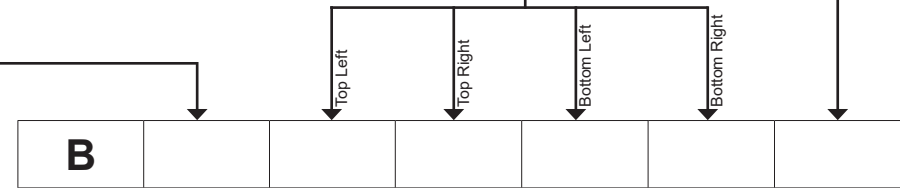

Insert your part number selection here	Actuator	Handing	Head	Push Escape Release Adaptor	Trapped Key Adaptors			Guard Switch / Guard Lock	Option Pod

Step 8: Networked Option Pods

Description	PROFINET	EtherNet/IP
Networked option pod fitted to guard interlock assembly.	D	H



am
If you have selected a *proNet* Option Pod then your *amCardpro* unit is now complete. If a *proNet* Option Pod isn't required, skip to wiring step 9.



Select your pushbuttons, selector switches and lamps from the control option section in this ordering sequence:

1. Top left
2. Top right
3. Bottom left
4. Bottom right

Connection Options		Part No.
3 QD set	1x male M12 power, 2x data.	07
4 QD set	1x male M12 power, 2x data, 1x M12 5-pin, external safety switch inputs.	09
4 QD set	1x male M12 power, 1 female M12 power, 2x data.	10
4 QD set	1x male power, 1x female power (5-pin 7/8"), 2x data.	11
4 QD set	1x male power, 1x female power (4-pin 7/8"), 2x data.	14
4 QD set	1x male M12 power, 2x data, 1x M12 8-pin M12 female to power a stop.	16
4 QD set	1x male M12 power, 2x data, 1x female for hardwired safety outputs.	19

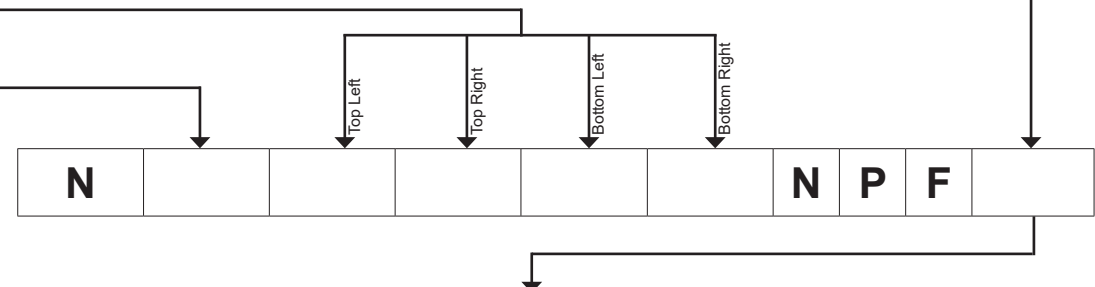

Insert your part number selection here	Actuator	Handing	Head	Push Escape Release Adaptor	Trapped Key Adaptors			Guard Switch / Guard Lock	Networked Option Pod

Quick Disconnects

Step 9: Quick Disconnect Connector Options

am

If no pre-wiring is desired or a *proNet* option pod selected, no quick disconnect connector is needed.



D1
5 Pin M12 QD



D3
8 Pin M12 QD



D7
10 Pin M12 QD



D8
12 Pin M12 QD



F2
19 Pin M23 QD

am

Fortress can wire *amGardpro* units to a customer's requirements or we can recommend a wiring scheme. Contact your local Fortress representative for details.

Wiring Diagram No.	Left	Right
T#####		

Insert your part number selection here	Actuator	Handing	Head	Push Escape Release Adaptor	Trapped Key Adaptors			Guard Switch / Guard Lock	Option Pod Selected	Quick Disconnects	Mounting Plates

Step 10: Accessories



Description	Information	Part No.
Cap	To terminate assemblies without heads.	C6



Description	Information	Part No.
Foot	To terminate non-switch configurations.	FT



Description	Information	Part No.
Drop down Lock-Out	Padlockable addition to amGardpro head modules. Padlock holes only align when actuator is removed.	DD7



Description	Information	Part No.
Lock-Out clip	Padlockable addition to amGardpro head modules. 3 x 8mm padlock holes only align when clip is fixed into head.	SL8 - suitable for 'S' head
		TL8 - suitable for 'T' head



FORTRESS

FORTRESS

“

We have the peace of mind that our workers are safe and protected by fortress equipment.

”



FORTRESS

“

Fortress is best at providing customised solutions at a rapid turnaround - reacting immensely to a challenge to put the customer's needs first.

”



FORTRESS

“

Fortress' best quality is providing each customer the most robust and safe solution - all while being completely customizable and retaining a high level of quality.

”



FORTRESS

“

We value suppliers that can help navigate the standards and provide guidance that is directly linked to our applications.

”



Fortress Global Offices

www.fortress-safety.com

Fortress Interlocks Ltd

☎ +44 (0)1902 349000
✉ sales@fortress-safety.com

Fortress Interlocks USA

☎ +1 (859) 578 2390
✉ us@fortress-safety.com

Fortress Interlocks China

☎ +86 (021) 6167 9002
✉ china@fortress-safety.com

Fortress Interlocks Europe

☎ +31 (0)10 7536060
✉ europe@fortress-safety.com

Fortress Interlocks Pty Ltd

☎ +61 (0)3 9771 5350
✉ australia@fortress-safety.com

Fortress Interlocks India

☎ +91 7042358818
✉ india@fortress-safety.com